



AC-交流机风扇 92x92x38mm

马达可选功能列表 (Available Functions)

1. 马达保护 (Moto protection)

AS

2. 信号输出 (Signal out put)

FG

RD

3. 调速方式 (Speed control mode)

PWM

TC



风扇单重:330g (weight:330g)

风扇P-Q曲线 / Fan performance curve

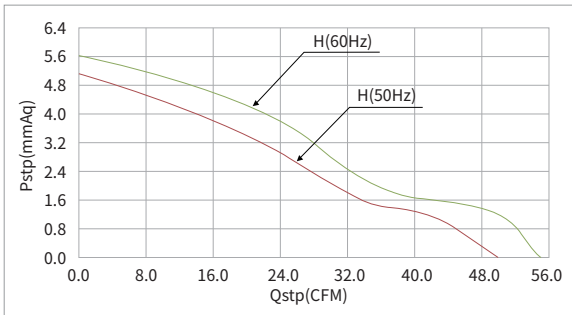

尺寸图 / Dimension drawing

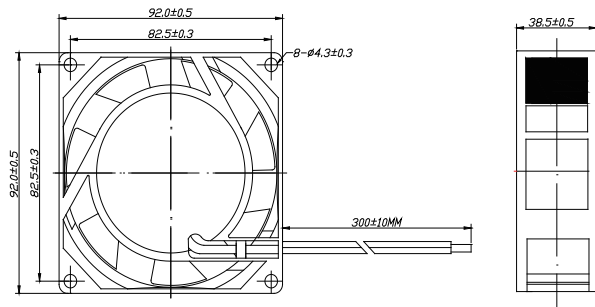

Model		Bearing	Rated Voltage	Voltage Range	Freq	Current	Speed	Air Flow		Static Pressure		Noise
型号	Type	轴承	额定电压	电压范围	频率	电流	转速	风量	风量	风压	风压	噪音
Part NO.	Type	System	VAC	VAC	Hz	A	RPM	M ³ /min	CFM	mmH ₂ O	INH ₂ O	dBA
HAB92110H38	W/T	Ball	110	100-125	50/60	0.16/0.14	2500/2700	1.42/1.56	50/55	5.1/5.6	0.20/0.22	39/41
HAB92220H38	W/T	Ball	220	200-240	50/60	0.08/0.07	2500/2700	1.42/1.56	50/55	5.1/5.6	0.20/0.22	39/41